

10 TIMBER BALUSTRADE

The current version of this document is on the internet. Printed version & prices may be superseded. All material subject to copyright.

SPECIAL PRICE
 Stock **TB6** Hardwood
 Balustrade Panels
 1000mm x 2500mm
 Raw White Primed
\$366 \$500
 1000mm x 3000mm
 Raw White Primed
\$429 \$593
 Prices per panel. Breadloaf
 handrail only. Available July 2024

All balustrade prices in our product catalogue

how to measure and
 install balustrade
 video



ground level only - no pool usage

Woodworkers □
Union Jack 2 Rail Balustrade
 TB1 (circa 1820 - 1880)

Woodworkers □
Union Jack 3 Rail Balustrade
 TB2 (circa 1820 - 1880)

Woodworkers □
Diagonal Ring 3 Rail Balustrade
 TB3 (circa 1850 - 1880)

Note: Prices listed for TB1, 2 and 3 assume consistent sized panels. Projects where large variations occur in panel lengths where additional set out is required may attract a surcharge.

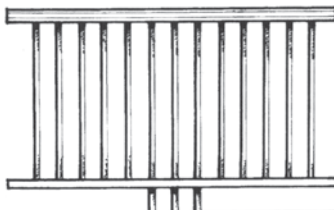

Woodworkers □
Dowel 2 Rail Balustrade
 TB5 (circa 1880 - 1914)

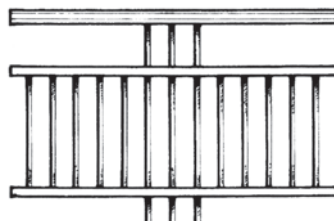

Woodworkers □
Cricket Stump 3 Rail Dowel Balustrade
 TB6 (circa 1900 - 1920)

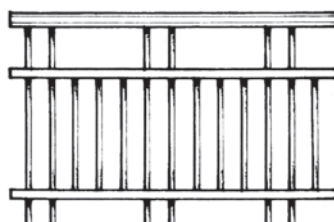

Woodworkers □
Double Stump 3 Rail Dowel Balustrade
 TB7 (circa 1900 - 1920)

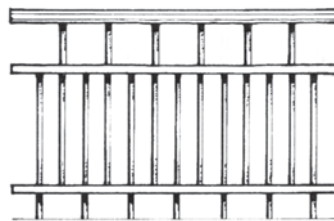

Woodworkers □
Alternate Stump 3 Rail Dowel Balustrade
 TB12 (circa 1900 - 1920)

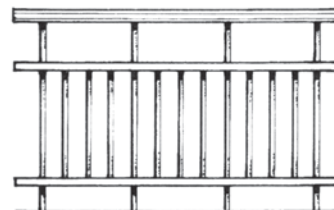

Woodworkers □
Single Stump 3 Rail Dowel Balustrade
 TB8 (circa 1900 - 1920)

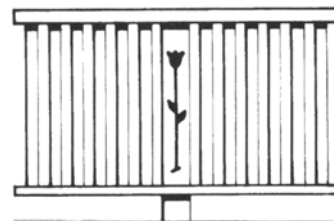

Woodworkers □
2 Rail Slat Balustrade
 TB9 (circa 1920 - 1938)

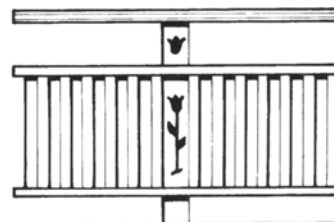

Woodworkers □
3 Rail Slat Balustrade
 (show with fretworked motif panel)
 TB10 (circa 1920 - 1939)

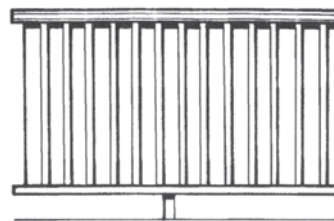

Woodworkers □
2 Rail Square Balustrade
 (31 x 31 square dressed balustrade)
 TB11 (contemporary)

The style of timber balustrades provides one of the best clues to the age of old houses. Before 1880 virtually all Queensland houses had Union Jack style balustrading, using slender timbers in compositions emphasising a diagonal pattern. In the late nineteenth century cast iron was the fashionable balustrade material although simple two rail dowel or turned balustrades were also commonly used. By 1900 there was a resurgence in preference for timber balustrades again, with variations on the three rail dowel design being the hallmark of the Federation era. The inter-war period was characterised by a shift to slatted balustrade in lieu of dowels, often with fretworked motif panels or constructed entirely from fretworked palings.

The woodworkers Company supplies balustrading made from hardwood in pre-assembled panel form, custom built for each column spacing. Stair balustrading in pre-assembled form is also available, together with matching timber valances to trim the lintel beam above the handrailing.

WHAT WARRANTY IS PROVIDED?

Balustrade carries a 12-month manufacturer's warranty based on correct installation and the use of oil-based finishing products as recommended in FAQ 01.

Woodworkers' balustrade is often more than 20% cheaper than our major competitors and it's better!

Website: www.woodworkers.com.au

Email: sales@woodworkers.com.au

BRISBANE
 1095 Ipswich Rd
 Moorooka 4105
 ☎ 07 3848 1383
 ✉ 07 3892 1476

GOLD COAST
 Warehouse Road
 Southport 4215
 ☎ 07 5571 0088
 ✉ 07 5571 0617

SUNCOAST
 53 Wisers Road
 Maroochydore
 ☎ 07 5479 0999
 ✉ 07 5479 0911

SYDNEY
 2 Sydenham Rd
 Brookvale 2100
 ☎ 02 9938 4999
 ✉ 02 9938 4666



WHAT TYPE OF TIMBER IS USED

All rails, dowels and slats are manufactured from kiln dried hardwood. Feature panels (used in TB9 + 10) are LOST treated pine. We avoid the general use of pink pine componentry because it will not have the durability or strength of genuine hardwood.

WHAT HEIGHT IS IT AND WHAT LENGHT CAN WE GO IP TO?

Woodworkers balustrading is 1000mm high as standard but other heights are available if matching or replacing existing balustrades. The Building Code requires minimum height of 1000mm if the potential fall off the verandah or deck is greater than 1000m. It is best to check with your local council or certifier if in doubt-especially if replacing or matching existing panels. We recommend a maximum length of 3000mm. Larger panels can be made on request but engineering advice would be required to ascertain their suitability.

HOW FAR APART AND WHAT SIZE ARE :

The Dowels

Dowels are 25mm diameter (other sizes are available at additional cost). Each panel is individually plotted/spaced using 100mm centres as the basic calculation.

The Slats

Our standard slats are 67mm wide and 19mm thick. These are spaced using a 50mm gap as a guide but because each panel is individually plotted this gap will vary thus avoiding a slat being too close to a post or column.

The Rails

The gap between top and mid rail is not permitted to be greater than 125mm. Likewise the gap between the verandah/deck and the bottom rail cannot be greater than 125mm. Woodworkers preassembled balustrading has a gap of approximately 120mm between top and mid rail and approximately 100mm between deck and bottom rail.

WHAT RAIL PROFILES ARE AVAILABLE?

Woodworkers offers a choice of 4 standard top rails



These are all approximately 67mm x 67mm and are sold at the same price for each style.

NOTE
The bottom rail sill profile must face inwards to meet building regulations. The slats must not be able to be kicked out from internally.

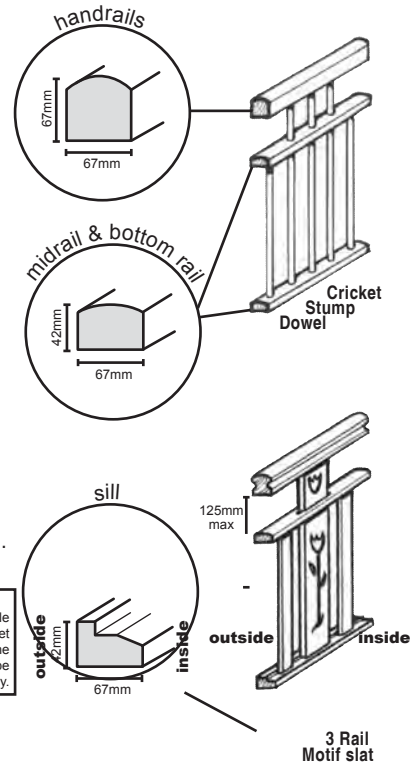

Woodworkers offer a choice of mid rail and bottom rail profiles (TB5,6,7,8). Our standard mid and bottom rail profiles have a round top - similar to the Breadloaf top rail - this was traditionally used to help with rain water flow off. Alternatively a square dressed rail is available at the same price. All mid and bottom rails are approx 68mm x 42mm. The same choice (round top or square dressed) is available with the TB10 mid rail.

WHY DO THE SPACINGS DIFFER SLIGHTLY FROM PANEL TO PANEL?

Woodworkers plot each panel individually to avoid having peculiar spacings at the junctions with the posts. The photo shows what happens when the slats or dowels are set out without regard to the column spacings. Note also that the absence of a gap between the column and the slats, accentuates any lean that is common with verandah columns. The balustrade in the photo isn't self-draining, and isn't safe as the slats can easily be kicked out from the verandah side. Woodworker's balustrade has shapes on the horizontal surfaces to shed water, and the bottom rail is designed to provide a physical stop to safely prevent any potentially dangerous accidents with the uprights being dislodged.

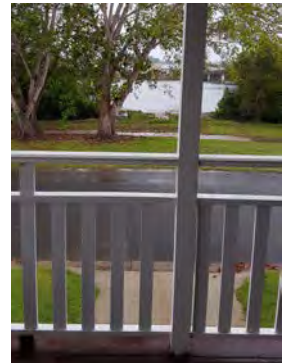

WHAT FEATURE PANELS CAN I CHOOSE?

Woodworkers standard feature panel is 116mm wide and pricing reflects this standard size. Other sizes may be available.

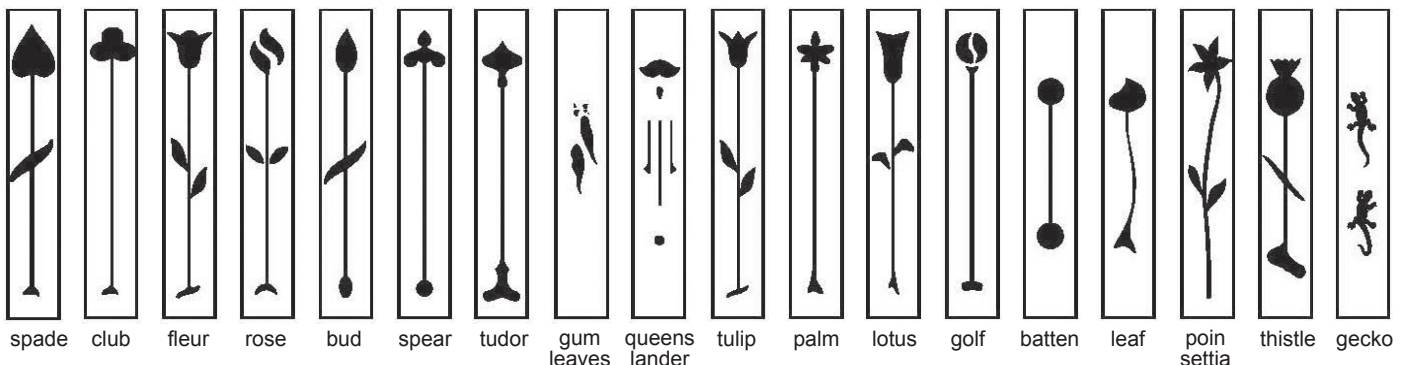



it's hard to beat hardwood for balustrade. Pink prime pine doesn't last the time.

The current version of this document is on the internet. Printed version & prices may be superseded. All material subject to copyright.



DO WOODWORKERS SELL COMPONENTS FOR D.I.Y ASSEMBLY?

NO. Only the top rails are available in raw material form.

CAN BALUSTRADING BE USED INDOORS?

YES. But designs and finish are the same as for external balustrades i.e. not furniture grade.

WHAT DESIGNS CAN I USE?

All of Woodworkers designs conform to current building standards and can be used in most situations. You can also create your own design. The only design not suitable in some circumstances is TB1, 2 & 3, which cannot be used on verandah/decks more than 4metres above the surface beneath. It is always best to check with your local council/certifier.

WHAT IS VALANCE?

A valance is a panel generally situated under the lintel that matches the balustrade below. Valences are often used where lintel beams are unusually high eg. 2400mm + or where houses have been raised and a valance is installed below the balustrade to disguise and soften the proportions of the elevations.

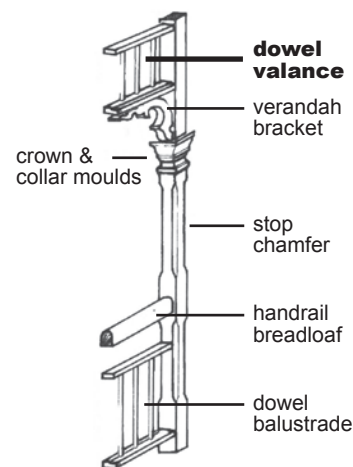

CAN WE USE BALUSTRADES FOR POOL FENCING?

YES. However the overall height must be extended to 1200mm minimum and a price increase is incurred (POA).

HOW LONG WILL THE BALUSTRADE LAST?

Hardwood timber when correctly installed, sealed and painted will last a lifetime. Many homes have hardwood balustrading over 100 years old.

HOW DO YOU FIX TO POSTS?

At a small additional cost Woodworkers offers the option of a false tenon fixing system; top and bottom rails have a 19mm x 19mm groove on their underside which neatly takes a special plug that is installed in to your posts. This service is not available for raking panels as this fixing system is unsuitable for angled connections. Small galvanized steel angle brackets can also be used. Woodworkers recommend 75 x 75 x 15 x 3mm thick brackets on handrail. We do not recommend only skew-nailing. On all installations Woodworkers recommends the use of galvanized nails (65 x 3.75mm) and/or galvanized steel screws (No.10). In most situations balustrading is a decorative safety barrier and therefore professional standards of installation and fixing should at all times be achieved. Woodworkers recommends the use of a qualified installer or the consultation of Timber Queensland Limited Technical Data Sheet 23. If in doubt contact a qualified certifier.

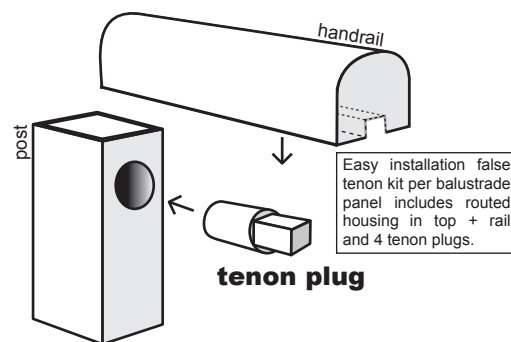

WHAT IS THE INSTALLATION SEQUENCE?

1. Ensure panel is centered, scribe both sides and then trim ends to size as necessary.
2. Place panel in position making sure rails are horizontal. Mark on posts underside of bottom rail (& underside of top rail if installing 2 rail configuration).
3. Using a 25mm spade bit put point of spade bit 10mm above mark and drill a 25mm deep hole.
4. Insert plugs bottom flat side of square plug should line up with mark on posts. Glue into position.
5. Slide rails/panels down onto plugs and into position. A couple of 65 x 3.75mm galvanized nails (pre-drilled) or screws should be used to secure rails into position from underneath.

CAN THE BALUSTRADE COME PRE-PRIMED? **Priming service temporarily unavailable due to staff shortages in spray booth.**

Yes. We can fully prime balustrading in oil based white primer or Sikkens clear at additional cost. We always prime the lower ends of dowels or slats to ensure a sealed end grain. The primer used is Sikkens. Once installed we recommend that the product be sealed and primed to minimise surface cracking and bleeding.

We recommend that balustrading be sealed with oil based paint or sealer within 48 hours of delivery. All cuts should be sealed prior to installation. If slight surface cracking occurs a little light sanding might be necessary, followed by filling and a second coat of primer/sealer.

CAN THE TIMBER BE CLEAR FINISHED?

Yes. However we cannot guarantee species or colour continuity; although this can sometimes be achieved if we are advised clear finishing is proposed. When clear finishing we recommend 1 coat of Sikkens HLS (available in colours) + 2 coats of Sikkens Cetol deck satin 078.

WILL THE TIMBER SPLIT OR CRACK?

It is in the very nature of hardwood for its surfaces to slightly split or crack. The hardwood timbers used have a durability class suited specifically for the purpose of verandah rails and although are seasoned hardwood, a small amount of surface splitting/cracking might occur. This is especially so in the drier and colder months of the year.

CAN WE CREATE OUR OWN DESIGN?

Yes. Woodworkers can quote on other designs & patterns if you need to match existing balustrading or you can create your own pattern & design.



BRISBANE
1095 Ipswich Rd
Mooroooka 4105
☎ 07 3848 1383
F: 07 3892 1476

GOLD COAST
Warehouse Road
Southport 4215
☎ 07 5571 0088
F: 07 5571 0617

SUNCOAST
53 Wisers Road
Maroochydore
☎ 07 5479 0999
F: 07 5479 0911

SYDNEY
2 Sydenham Rd
Brookvale 2100
☎ 02 9938 4999
F: 02 9938 4666

10 TIMBER + IRON BALUSTRADE

The current version of this document is on the internet. Printed version & prices may be superseded. All material subject to copyright.

THE
WOODWORKERS
COMPANY

HOW DO WE MEASURE FOR STEPS/RAKE?

To calculate the angle of steps we need to know the height of a step (top of one step to top of the next step) and the width of the step (from the front of one step tread to the front of the next step tread). Also required is the distance from post to post i.e. the distance down the length of the stringer. On lengths 2 metres and over it is best to supply us with measurements taken from the top & bottom steps.

HOW WIDE CAN BALUSTRADE GATES BE?

We recommend a gate be no wider than 600mm. If a need exists for a wide gate then a support wheel should be attached on the swinging end of the gate or proper mortise and tenon joinery ordered.

HOW DOES THE COST OF WOODWORKERS BALUSTRADING COMPARE?

Best value available. Woodworkers assembled balustrading is usually cheaper than buying component parts from other suppliers and having to put it together yourself. With our assembled balustrading all the work is done for you at a great price and every panel is individually plotted to suit your exact needs. This ensures you have no dowels or slats at odd spacing next to your posts. Our assembled balustrading is unbeatable quality for price and we also offer fully assembled panels for gates, steps, valances and ramps.

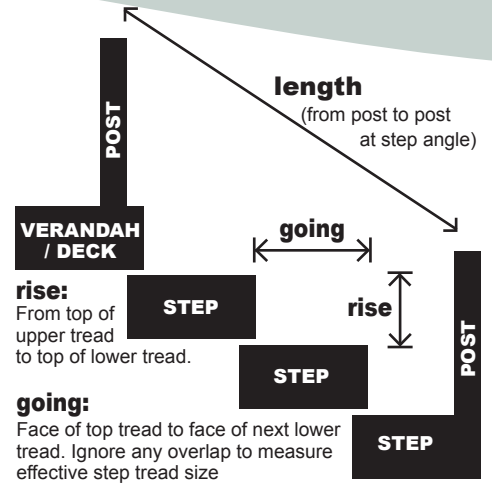

how to measure the step rake

timber and iron external balustrade

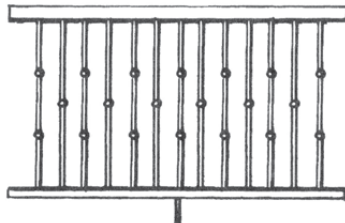

Woodworkers'
Offset Collar Iron Balustrade
TS2 (Type "A" collar only)

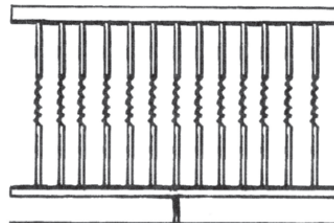

Woodworkers'
Centre Twist Iron Balustrade
TS3

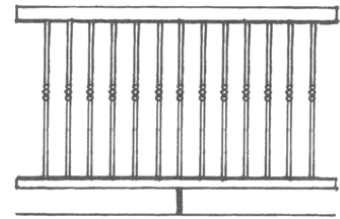

Woodworkers'
Mid Collar Iron Balustrade
TS1 (Type "B" collar only)

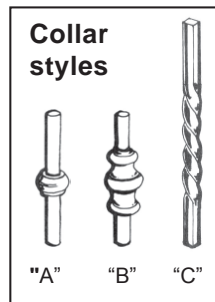
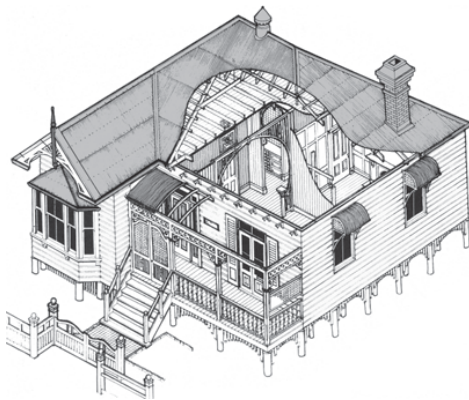

Collar
styles

"A" "B" "C"

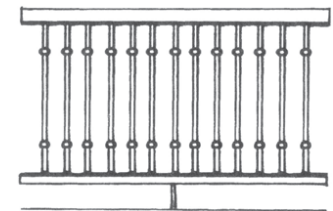

Woodworkers'
Margin Collar Iron Balustrade
TS4 (Type "A" collar only)

At a fraction of the cost of all iron balustrading, Woodworkers' makes a range of black powdercoat baluster designs set in hardwood rails to achieve a fresh European look, Installation is simple and cost effective, without the need for specialist metalworkers.

FAQs

All balustrade prices in our product catalogue

WHAT SIZE IS THE STEEL IN THE TIMBER AND IRON EXTERIOR BALUSTRADE?

All steel is 12mm. In TS1,2 & 4 the steel is 12mm round and in TS3 (twist) the steel is 12mm square, powder coat finished.

CAN POWDER COATED BALUSTRADING BE USED IN A SEASIDE ENVIRONMENT?

No. However in areas of high exposure a zinc powder protection primer (zinc shield2) can be applied prior to the top powdercoats. This costs an additional \$40 per meter.'

WHAT GUARANTEE COMES WITH POWDER COATED BALUSTRADING?

When used externally Dulux give a 7 year colour integrity film guarantee - refer to their website www.duluxpowders.com.au for further information.



Compare our prices!

Website: www.woodworkers.com.au

Email: sales@woodworkers.com.au

BRISBANE
1095 Ipswich Rd
Moorooka 4105
☎ 07 3848 1383
F: 07 3892 1476

GOLD COAST
Warehouse Road
Southport 4215
☎ 07 5571 0088
F: 07 5571 0617

SUNCOAST
53 Wisers Road
Maroochydore
☎ 07 5479 0999
F: 07 5479 0911

SYDNEY
2 Sydenham Rd
Brookvale 2100
☎ 02 9938 4999
F: 02 9938 4666